

EPIC STEEL

NAIL STRIP

NAIL STRIP

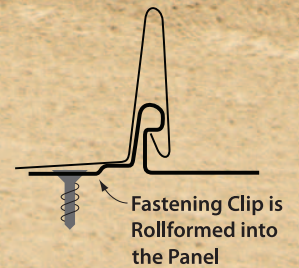
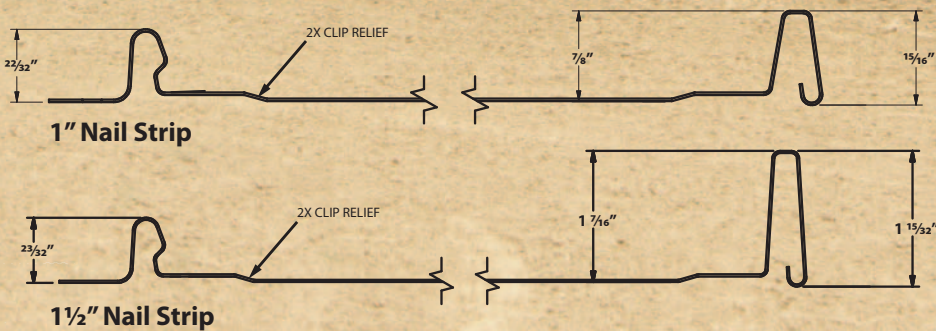

EPIC STEEL

NAIL STRIP

Table of Contents

General Notes

Claims	1
Returns	1
Storage	1
Handling	1
Foot Traffic	1
Safety	2
Field Cutting Panels	2
Condition of Substrate and Structure	2
Tools & Equipment	3
Roof Maintenance	3
Paint Warranty	3
Installation	4
Fastener and Selection Guide	5-6
Material Specifications	7

Flashing Details

Trim Profiles	8
Hem Lengths	9
Style D Eave	10
Style D Eave With Gutter	10
Venting Hip / Ridge	11
Hip / Ridge	11
Locking Sidewall	12
Locking Endwall	12
W - Valley	13
Locking Gable	13
Prow Gable	14
Style D as Gable	14
High Eave	15
Style D as High Eave	15
Standing Seam Upper Transition	16
Standing Seam Lower Transition	16
Locking Inside Corner	17
Locking Outside Corner	17
Standing Seam Window Drip	18
Standing Seam Base Trim	18
J - Metal Trim	19
Header / Sill Trim	19
Penetration Detail	20

EPIC STEEL

NAIL STRIP

INFORMATION

This guide has been provided as a reference and helpful tool for installing Epic Steel's Nail Strip. The installation details shown may not apply to all building designs, codes, or product applications. It is the responsibility of the installer to ensure the details meet code in his/her area.

Epic Steel reserves the right to change any information in this guide, at any time, without notice. If you have any questions or concerns, please contact your Epic Steel representative.

CLAIMS

It is the responsibility of the customer to review the condition and quantities of an order upon pick up or delivery. Claims for any shortages or damages must be filed immediately for orders picked up, or within 7 days for orders delivered. Epic Steel will not be held responsible for any claims filed after these time frames.

RETURNS

Epic Steel does not accept returns of any custom ordered materials, special ordered accessories, or fabricated metal products. Only stock accessories may be returned if they are deemed to be in resalable condition. Stock items being screws (full bag quantities), flashers, closures, clips, underlayment, etc. A restocking fee of 15% may be applied to all returned merchandise.

STORAGE

If the metal panels or trim are not used immediately, the metal should be stored in a well ventilated, cool, dry place. This will inhibit moisture build up on the panels and trim, which can lead to white rust.

If the product cannot be stored indoors, elevate one end of the bundle to allow any moisture to run off the panels. Also, a tarp should be loosely wrapped around the bundle, ensuring there is good air flow around the panels. Never store panels in direct contact with the ground.

Epic Steel assumes no responsibility for materials that are not stored properly.

HANDLING

Handle all panels and trim with care to avoid damage. When unbundling panels, do not drag one panel against another. This can cause scratches across the panels. When moving the panels, they should be carried vertically to the ground by grasping the edge of the panel carefully to ensure that no excessive bending occurs. Note, the edge of the panel is sharp, and gloves should always be worn when handling all metal.

When handling trim it is important to do so with care and ease. Many trim profiles are fragile and can be easily damaged if not handled appropriately. It is recommended that the installer or whomever is handling trim wear gloves and use two hands at all times.

FOOT TRAFFIC

Care of metal panels and trim must be exercised throughout installation. Foot Traffic can cause distortion of the panel and damage the finish. Foot traffic should be kept to an absolute minimum. Installers should wear soft soled shoes that will help with traction on the roof and prevent scratching.

When walking on the panels is unavoidable, walk in the flats only. Walking on the major ribs can damage the panel.

EPIC STEEL NAIL STRIP

SAFETY

Safety should be the main concern when installing any metal project. Each job site presents different hazards, on the ground and the roof; therefore, it is the responsibility of the installer to determine the safest way to install the metal.

Personal protective equipment should be used at all times when handling or installing metal panels and trim (i.e. gloves, safety glasses, pants, long sleeved shirts and hard hats).

Always be aware of your surroundings and use fall protection. Never install metal roofing during windy or stormy days. Metal roofing can become slippery when wet or dusty and extra care needs to be taken if these conditions are present. Wind can create hazardous working situations by getting under the metal panel and pulling the installer off the roof. Metal roofing is very sharp and can cause serious bodily injury if handled inappropriately.

If a safety concern exists on a job site, stop work immediately. Always comply with OSHA safety regulations.

FIELD CUTTING PANELS

Tin Snips, or a nibbler is recommended for field cutting metal panels and trim. Always wear eye and ear protection when cutting metal. When cutting painted metal, ensure the metal particles and fragments do not end up on the painted surface. Metal particles on the painted surface will result in rusting and pitting in that area. Epic Steel recommends the panels to be turned upside down and all cutting be done looking at the backside of the material. Installers should immediately wipe away any debris from the material after cuts to prevent this problem. Panels should be cut in an area where metal particles do not end up on other panels or building materials.

Failure to remove the metal particles from the panel will void any warranty

CONDITION OF SUBSTRATE AND STRUCTURE

Before the installation process begins, it is critical that the framing and substrate are inspected to ensure that the structure is square and plumb. If it is not, it will have to be corrected. Make sure any structural fixes are done by someone with the proper experience and knowledge. Correct any objectionable warp, waves, or buckles in the substrate before proceeding with panel installation. The roof panels will follow the contour of the structure and may appear irregular if not corrected.

To check the structure for squareness, take two diagonal measurements from the corner to corner. The roof is square if the two measurements are equal.

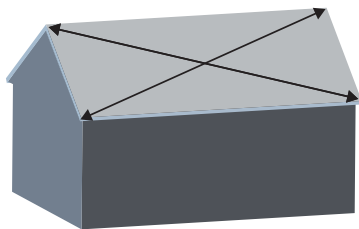

If the roof is not square, follow the 3-4-5 method to ensure that the panel is being installed square. If the first panel is not installed square, all remaining panels will also be out of square when attached to the structure.

- 1.) To do this, pick a starting point at the bottom corner of the roof, about a foot away. Set a nail there.
- 2.) From the nail, measure exactly 3 feet in the opposite direction along the bottom edge of the roof. Insert another nail in that spot.
- 3.) From the first nail, measure exactly 4 feet up the slope of the roof and draw a small arc.
- 4.) Measure from the second nail up to the arc measuring exactly 5 feet, drawing another arc.
- 5.) Attach a chalk line to the first nail and extend it up the slope to it passes through the intersection of the two arcs.
- 6.) Snap the chalk line. This line is now square with the bottom edge of the roof .
- 7.) Use this line to properly install the first panel square on the roof.¹

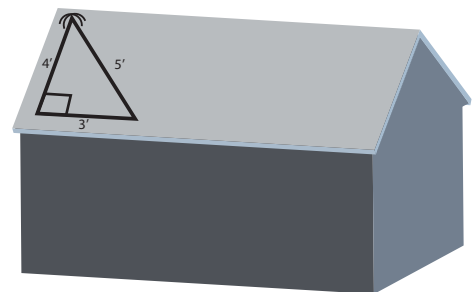

¹For larger roofs, this method can be done with multiples of 3,4,5 Example 6', 8', 10'

EPIC STEEL

NAIL STRIP

TOOLS & EQUIPMENT

- Hard Hat
- Gloves
- Safety Glasses
- Ear Plugs
- Fall Protection
- Screw Gun
- Tin Snips
- Tape Measure
- Chalk Line
- Electric Nibbler
- Circular Saw
- Angle Grinder
- Rivet Gun

ROOF MAINTENANCE

Roof maintenance should be done, at the minimum, annually. These steps will ensure that your roof will have a longer lifespan with less maintenance and help prevent costly repairs. It is best to perform roof maintenance when the weather permits safe working conditions.

- Clear all debris off the roof (dirt, rocks, branches, leaves, etc.)
- Clean out all drains and gutters to ensure proper drainage, to prevent water standing.
- Remove any overhanging branches or anything else that could penetrate the roof surface.
- Inspect all areas for leaks and deterioration - pay attention to stains and discoloration of the roof edges and surrounding walls as they are possible indications of a leak.
- Check roof penetrations for possible leaks and cracks in caulking.
- If exposed fasteners have been used to install the roof, it is crucial they are inspected annually.
 1. Check if they are installed correctly.
 2. Ensure that they are not fastened too tight or not tight enough.
 3. Inspect the integrity of the neoprene washer.

Refer to Fastener selection guide on the following pages 5-6.

PAINT WARRANTY

Warrant documents are available upon written request.

Please provide the following information to your local Epic Steel representative.

Product purchased - Including: panel type, width, color and gauge.

Where the product was purchased: Lumber yard, roofing wholesaler, contractor or direct.

When the product was purchased: Date of purchase (must be within 90 days of purchase date)

Owners Name and Contact Information:

Project Location: Physical address

Job Completion Date:

EPIC STEEL NAIL STRIP

INSTALLATION

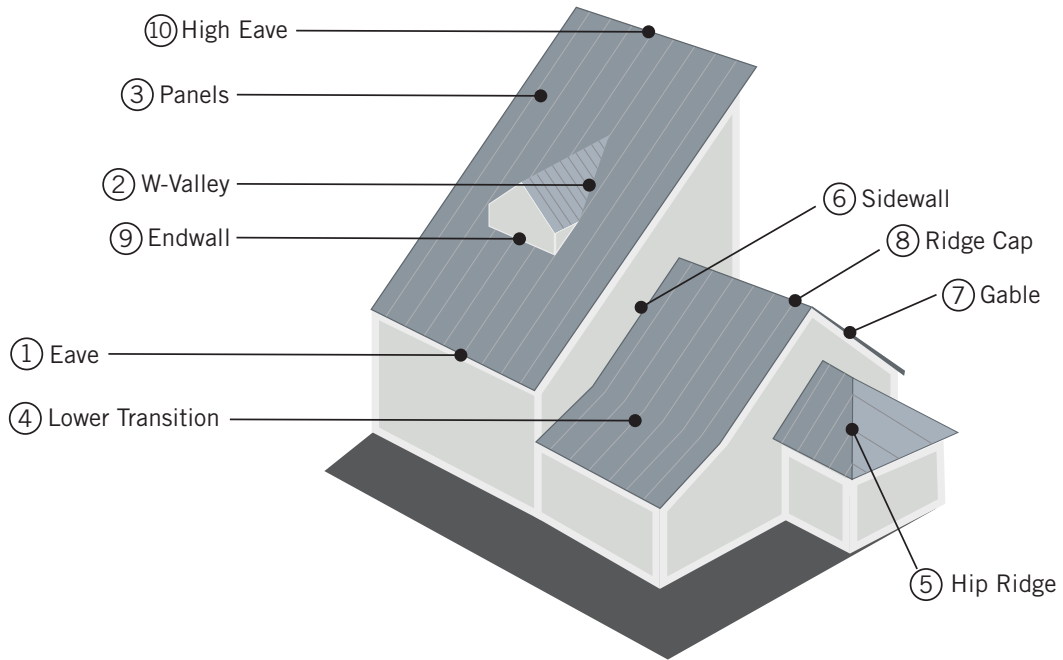

Installation over shingles is not recommended. It is best to remove shingles and install a new, synthetic underlayment to act as a vapor barrier between the substrate and the metal. If shingles will not be removed, furring strips need to be installed on the roof at 2'-0" centers. The metal panels will then be fastened to the furring strips.

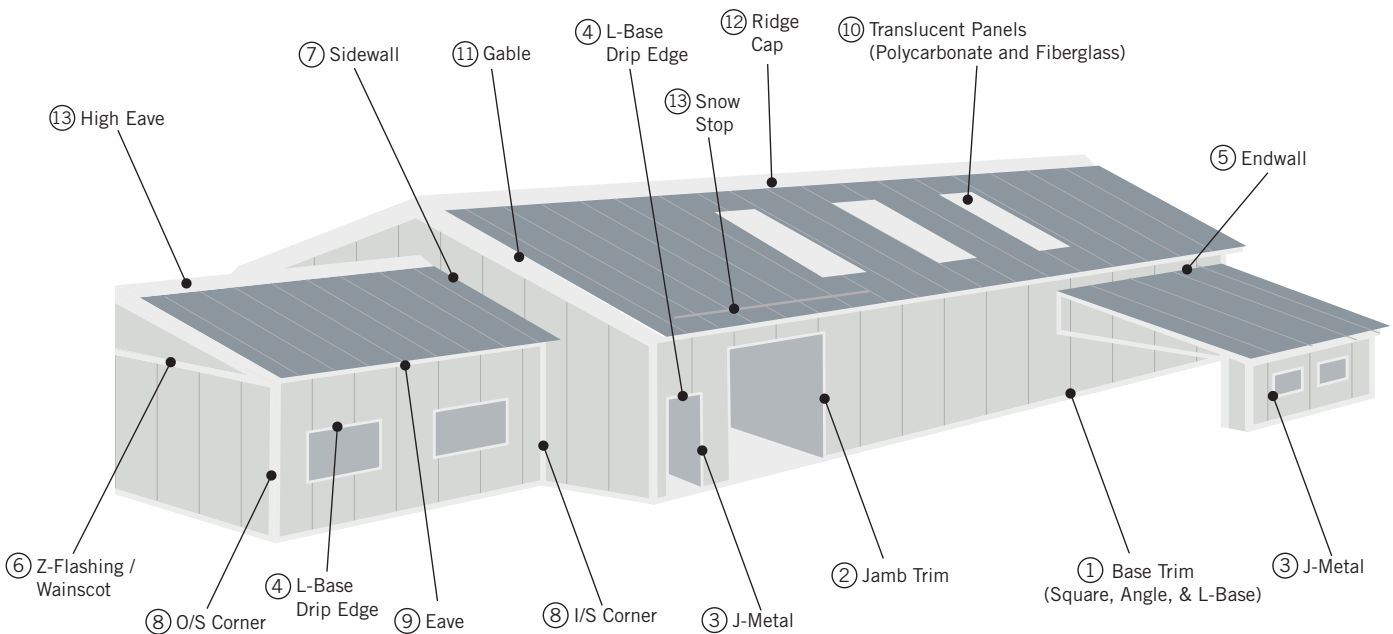

**Components are listed in the order that they are installed.*

**Please contact us for more information.*

EPIC STEEL

FASTENER SELECTION GUIDE

WOODFAST SCREW

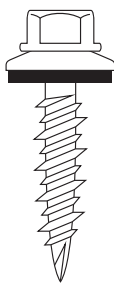

- No. 10 x 15, Type 17
- Available sizes: 1", 1 1/2", 2", 2 1/2", 3"
- 1/4" Hex Head
- Use: Panel to dimensional lumber and trim attachment.

WAFER SCREW

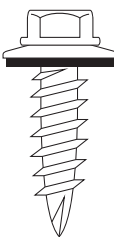

- No. 14 x 10, Type 17
- Available sizes: 1", 1 1/2", 2"
- 5/16" Hex Head
- Use: Panel to plywood/OSB substrate and trim attachment.

STITCH SCREW

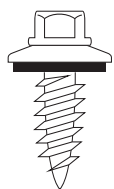

- No. 12 x 14
 - Available size: 3/4"
 - 1/4" Hex Head
 - Use: Trim attachment and stitching lap seams together (29 gauge).
- *Compatible with No. 10 & No. 14 Wood Screws*

TEK SCREW

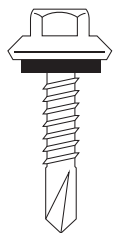

- No. 12 x 14
- Available sizes: 1", 1 1/2", 2"
- 5/16" Hex Head
- Use : Panel to Purlin (up to 3/16" steel).

PROPER INSTALLATION OF GASKETED FASTENERS



CORRECTLY DRIVEN

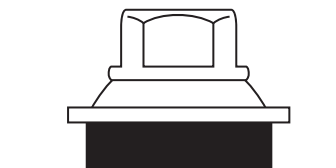

UNDER DRIVEN

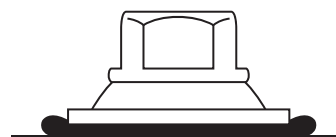

OVER DRIVEN

- This table shows the fasteners available from Epic Steel. Refer to the panel installation and flashing details of this manual for specific screw usage and spacing.
- Panel attachment screws must be long enough to fully penetrate through the wood roof decking, steel purlins or penetrate solid lumber at least one inch.
- All screws must be coated to provide protection against corrosion.
- Exposed fasteners must have sealing washers and should be the same color as the parts they attach.
- Screws must be properly driven to ensure proper seal and holding strength. Do not underdrive or overdrive the screws.
- Stainless steel rivets are not watertight.

EPIC STEEL

FASTENER SELECTION GUIDE

LAP TEK

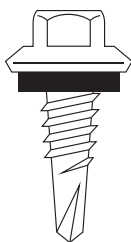

- No. 14 x 7/8"
- Available size: 7/8"
- 5/16" Hex Head
- Use: Trim attachment and stitching lap Seams together .

**Compatible with No. 12 Tek Screw and No. 14 Wafer Screw*

TEK 5

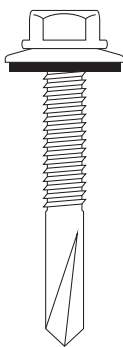

- No. 14 x 24
- Available size: 1 1/4"
- 5/16" Hex Head
- Use: Panel to purlin (Heavy Gauge Steel 3/16" and greater).

**Only Available in white and galvanized, remaining colors available by special order.*

PANHEAD

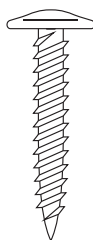

- 10 x 12
- Available sizes: 1", (1 1/2" and 2" available by special order)
- Phillips Head
- Use: To fasten standing seam panels and trim to wood deck (unexposed).

STAINLESS STEEL RIVET POP RIVET



- Available sizes: 1/8" x 3/16"
- Use: Trim attachment

PROPER INSTALLATION OF GASKETED FASTENERS

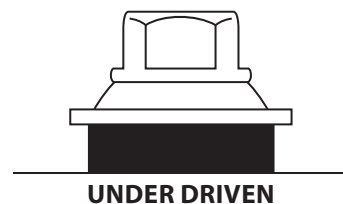

- This table shows the fasteners available from Epic Steel. Refer to the panel installation and flashing details of this manual for specific screw usage and spacing.
- Panel attachment screws must be long enough to fully penetrate through the wood roof decking, steel purlins or penetrate solid lumber at least one inch.
- All screws must be coated to provide protection against corrosion.
- Exposed fasteners must have sealing washers and should be the same color as the parts they attach.
- Screws must be properly driven to ensure proper seal and holding strength. Do not underdrive or overdrive the screws.
- Stainless steel rivets are not watertight.

EPIC STEEL NAIL STRIP

MATERIAL SPECIFICATIONS

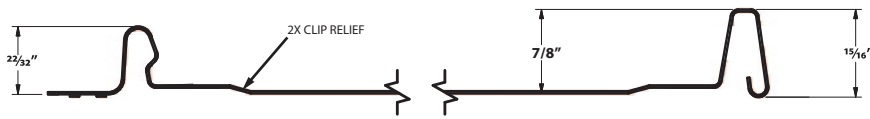

1" Nail Strip

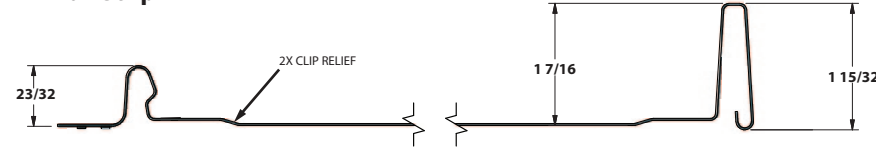

1 1/2" Nail Strip

Available Widths:

1" Nail Strip: 12.125", 16.125", 20.125"

1 1/2" Nail Strip: 15.125" & 19.125"

Available Gauges: 24 & 26

Weight: 1.00lbs/SqFt (24), .75lbs/SqFt (26)

Substrate: AZ-50, Grade D, 50,000ksi

Available Materials: Painted, Galvalume, Bonderized[®], 16 & 20 oz Copper

Paint Systems: Durapon70[™] PVDF, ULTRA CLAD[™] Kynar500[®]/Hylar5000[®], Valspar Fluorpon[®]

Warranties: Durapon70[™] PVDF – 35 year
ULTRA-CLAD[™] – 35 year
Zincalume[®] AZ50 – 20 year
Valspar[™] PVDF - 35 year
PPG[™] SMP - 40 year

Production Options: Either factory made to length with protective film to ensure damage free transport or rolled to length on site*

On site production is subject to order minimums

Panel Options: Flat panel and striations (flat panel requires a waiver).

Installation: Can be installed on solid wood decking.

Minimum Slope: 3:12

Testing For 1.5" Nail Strip:

- UL 580 Wind Uplift (Class 90)
- UL 2218 Class 4 Hail Impact
- UL 790 Class A Fire Rating



Please Note: It is the responsibility of the builder to ensure that they are compliant with current building codes.

LOAD TABLES

Refer to Trim Pamphlet for Material Availability

Panel	Width	Type	Test Type	Rating
1.5" Nail Strip	14.6" Panel	Uplift Resistance	UL	580 Wind Uplift (Class 90)
1.5" Nail Strip	14.6" Panel	Hail Rating	UL	2218 Class 4 Hail Impact
1.5" Nail Strip	14.6" Panel	Fire Rating	UL	790 Class A Fire Rating
1" Nail Strip	16" Panel	Uplift Resistance	UL	UL 90*
1" Nail Strip	16" Panel	Hail Rating	UL	Class 4 Impact UL 2218*
1" Nail Strip	16" Panel	Fire Rating	UL	Class A*

*Requires the use of Sheffield Metals coils/colors

Note: The tables have been compiled for the design of steel roofing and siding used in conjunction with either wood or steel framed structures.

APPLICATION DETAILS

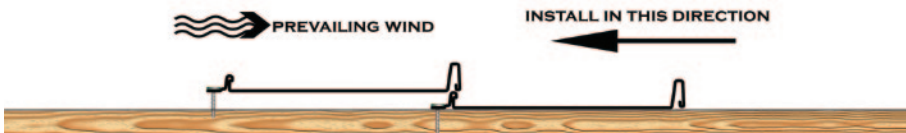

*Fastener Spacing 2' on Center

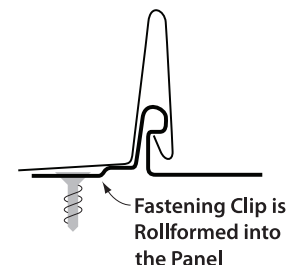

Epic Steel is neither partially or solely responsible for improper installation or defects as a result of installation

EPIC STEEL NAIL STRIP

TRIM PROFILES

10'0" STICK

Hip Ridge

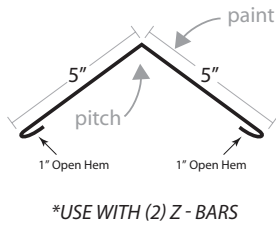

Box Gable

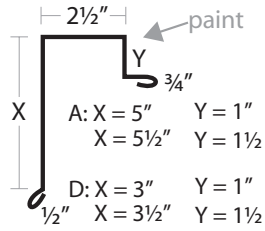

Z-Bar Gable

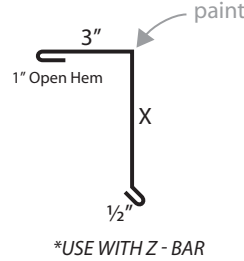

Locking Flush Gable

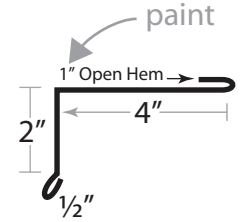

Eave (Style A Fascia)

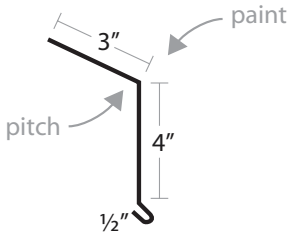

Style-D Eave

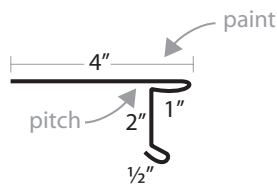

High Eave

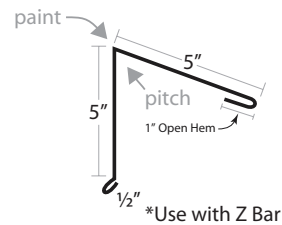

W-Valley

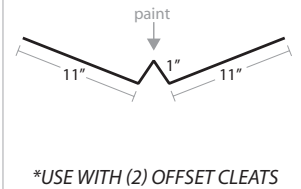

Locking W-Valley

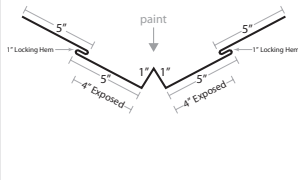

Endwall

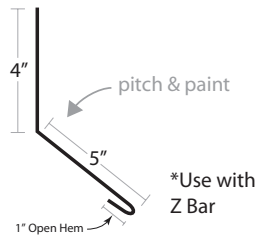

Locking Endwall

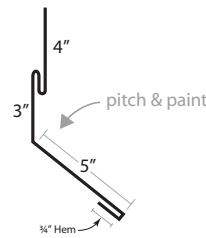

Box Sidewall

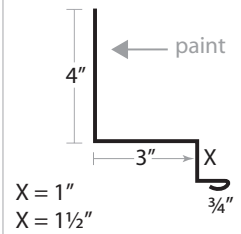

Locking Sidewall

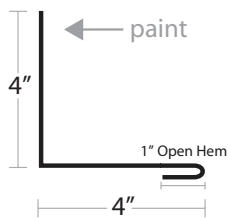

Upper / Lower Transition

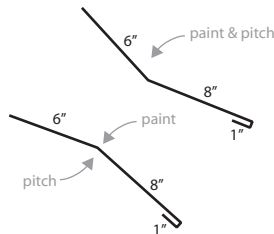

Locking Transition

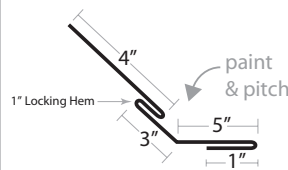

Chimney / Skylite Flashing

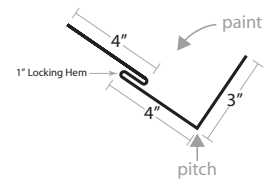

J-Metal

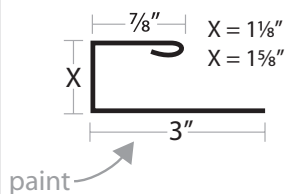

J-Bar

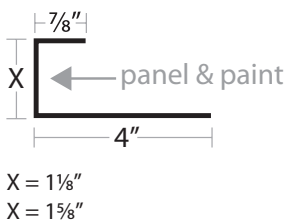

Z-Bar

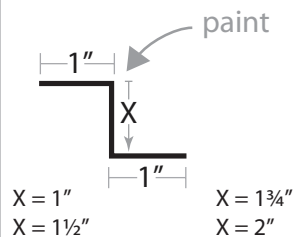

Offset Cleat

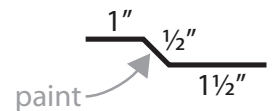

**Details are subject to change without notice.*

EPIC STEEL NAIL STRIP

HEM LENGTHS

A standing seam roof panel experiences changes in panel length with changes in panel temperature. One end of the panel is fixed to the substrate while the other end is free to move. The panel end that is free to move requires a hem that engages a cleat that is fixed to the substrate. The hem and cleat permit the panel end to move along the plane of the roof while holding the panel flat.

The thermal movement also requires proper design of the hem and cleat. The length of the hem needed at the end of a panel will vary with the temperature range that the panel experiences and the length of the panel. Unless a more exact analysis of the temperature during installation compared to the anticipated temperature range is conducted, use the following equation and the Thermal Movement Table. When installing panels, be sure to leave room at the end of the cleat. Be sure that the hem is not tight against the cleat (unless the panels are being installed in the coldest temperatures the panel will experience). Also be sure that the lower edge of the hem will not contact any flashings when the panels contract.

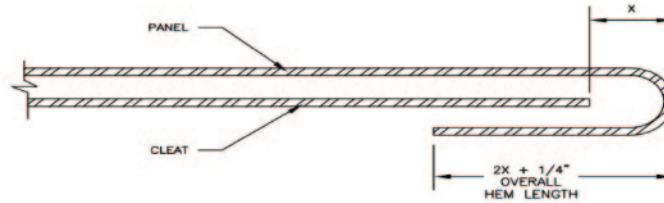

THERMAL MOVEMENT TABLE

PANEL AND SUBSTRATE MATERIALS	PANEL LENGTH (FT.)			REQUIRED AIR SPACE (X)
	10'	50'	100'	
Steel on Rigid Insulation	1/8"	1/2"	7/8"	
Steel on Wood	1/16"	3/8"	5/8"	
Steel on Steel	1/16"	3/8"	5/8"	
Steel on Concrete	1/16"	3/8"	1/2"	
Aluminum on Rigid Insulation	3/16"	7/8"	1 9/16"	
Aluminum on Wood	3/16"	11/16"	1 3/8"	
Aluminum on Steel	1/8"	5/8"	1 3/16"	
Aluminum on Concrete	1/8"	5/8"	1 1/4"	

This table assumes a temperature change of 100°F for the panel and 50°F for the substrate.

EPIC STEEL NAIL STRIP

STYLE D EAVE

PLYWOOD SUBSTRATE
#10 X 1" PANCAKE HEAD
SCREWS @ 12" O.C.

PANEL
APPROVED
UNDERLAYMENT
APPROVED SEALANT
BETWEEN SEAMS

EAVE TRIM
FASCIA TRIM (IF REQ'D)
TRIM BOARDS,
BY OTHERS

ALLOW FOR
THERMAL EXPANSION

NOTE:
MIN. 4" LAP ON ALL FLASHING.
APPROVED SEALANT IN ALL
FLASHING LAPS.

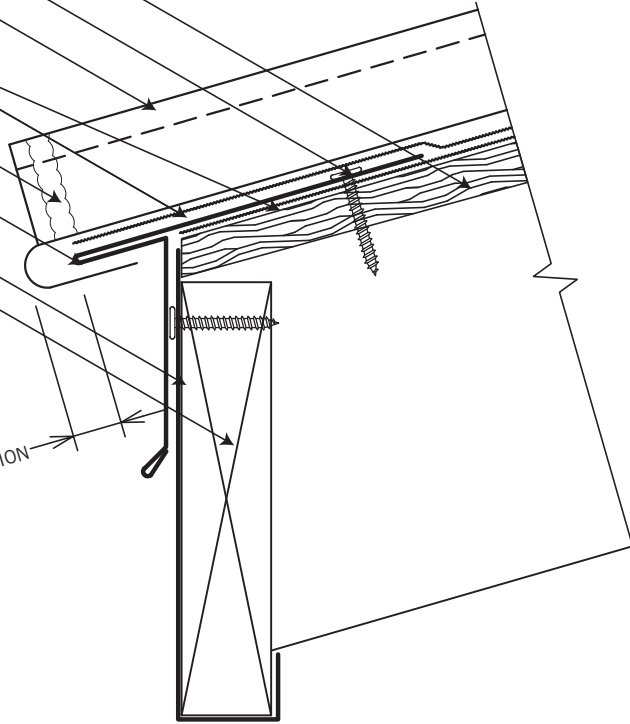

STYLE D EAVE W/ GUTTER

PANEL
PLYWOOD SUBSTRATE
#10 x 1" PANCAKE HEAD
SCREWS @ 6" O.C.

APPROVED
UNDERLAYMENT
APPROVED SEALANT
BETWEEN SEAMS
EAVE TRIM

FASCIA TRIM
(IF REQ'D)
TRIM BOARD,
BY OTHERS
GUTTER HANGER W/
SELF SEALING
WASHER, 24" O.C. MAX.
GUTTER
SYSTEM

ALLOW FOR
THERMAL EXPANSION

NOTE:
MIN. 4" LAP ON ALL FLASHING.
APPROVED SEALANT IN ALL
FLASHING LAPS.

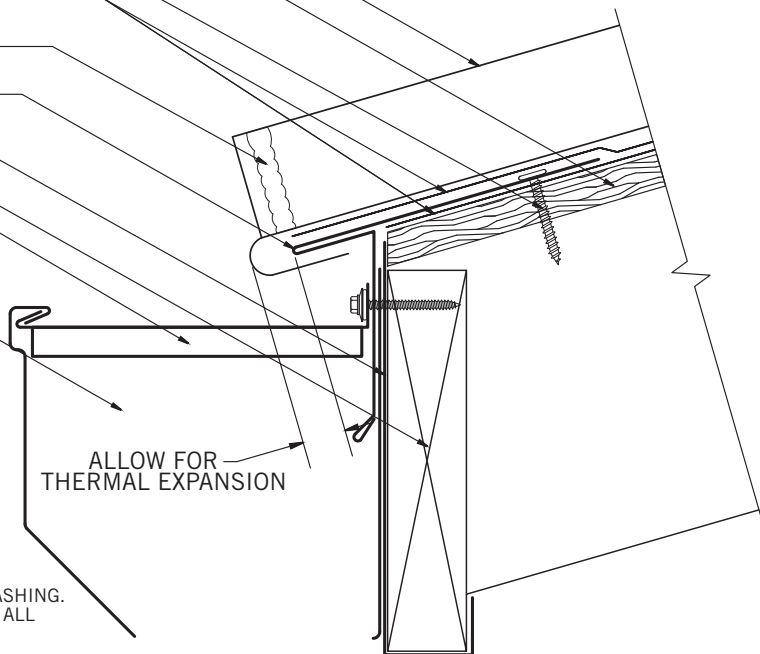

**Details are subject to change without notice.*

EPIC STEEL NAIL STRIP

VENTING HIP / RIDGE

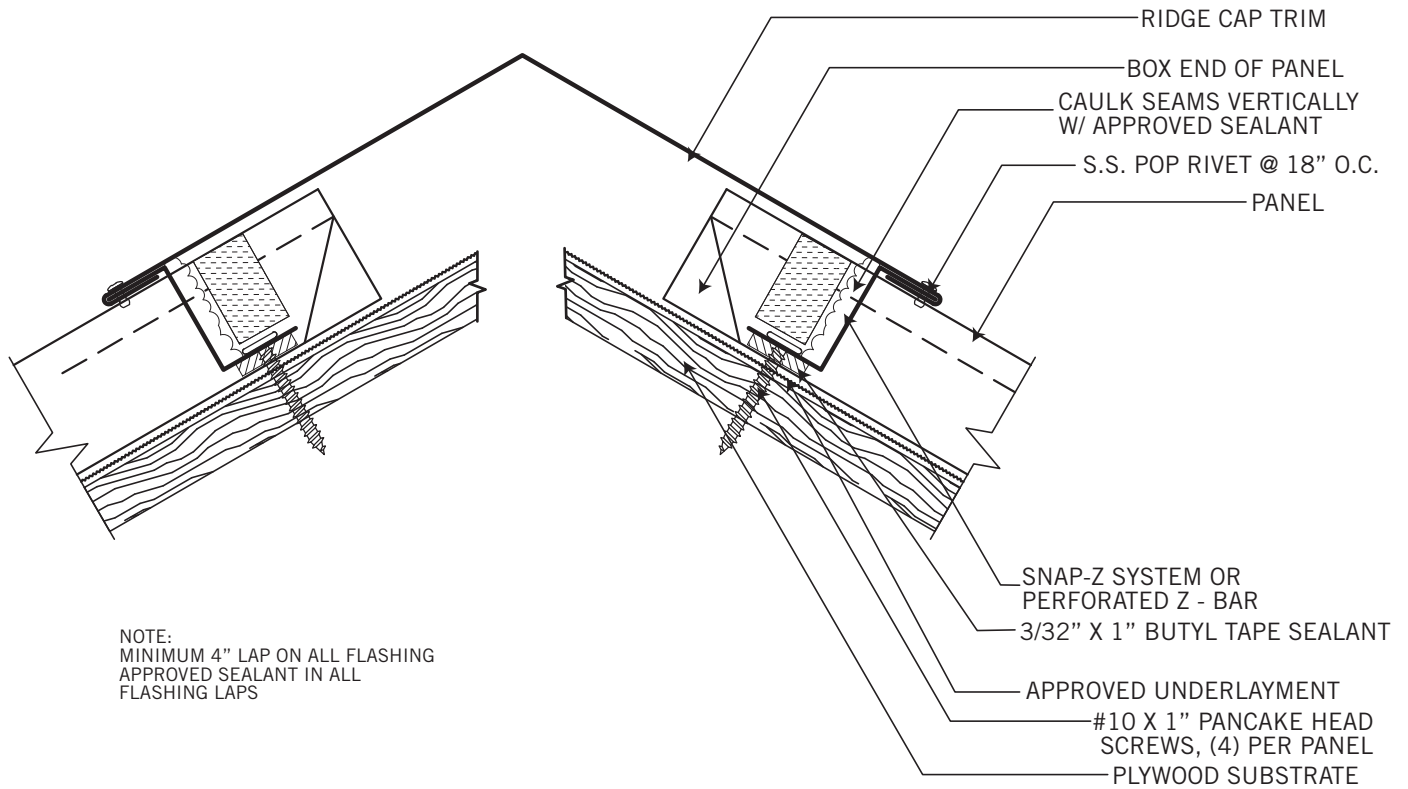

HIP / RIDGE

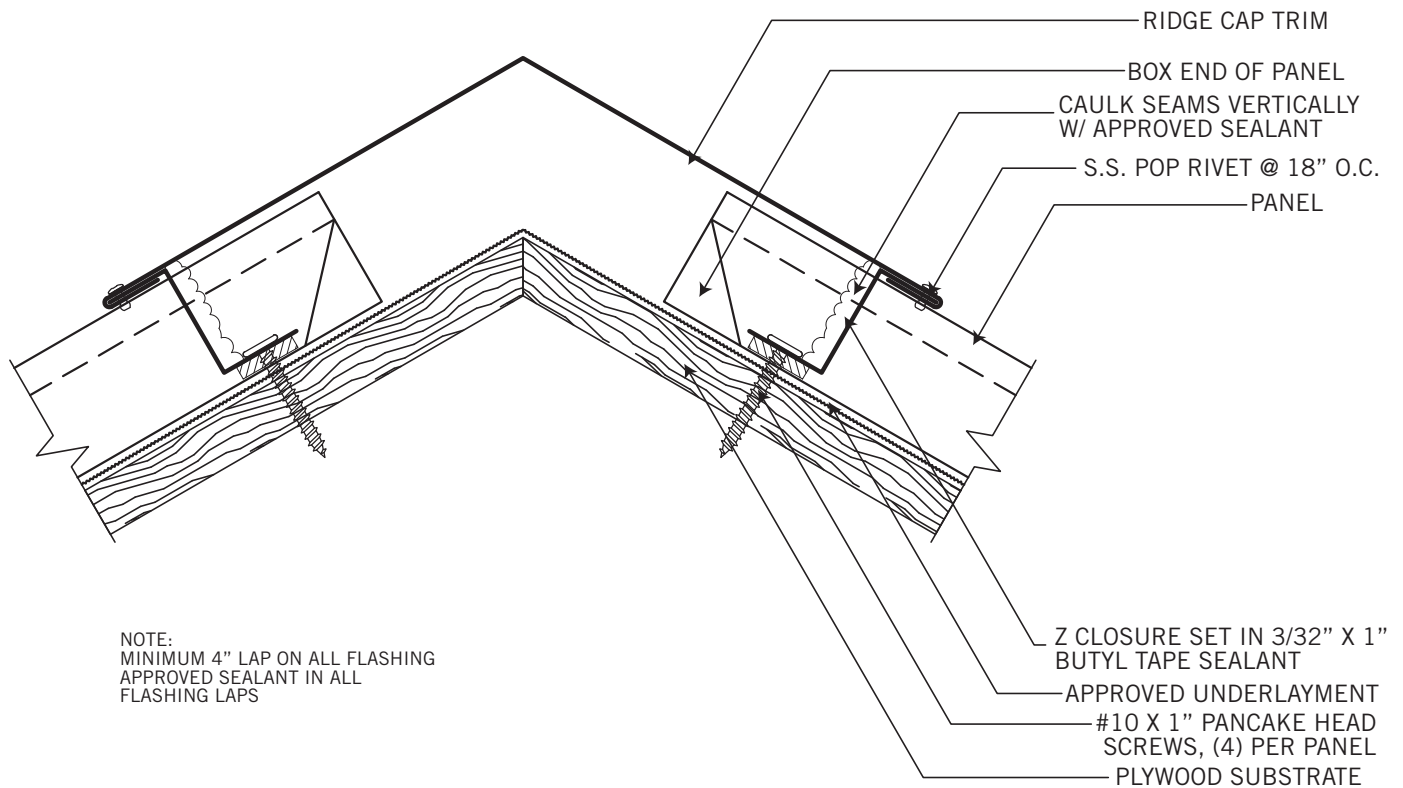

**Details are subject to change without notice.*

EPIC STEEL NAIL STRIP

LOCKING SIDEWALL

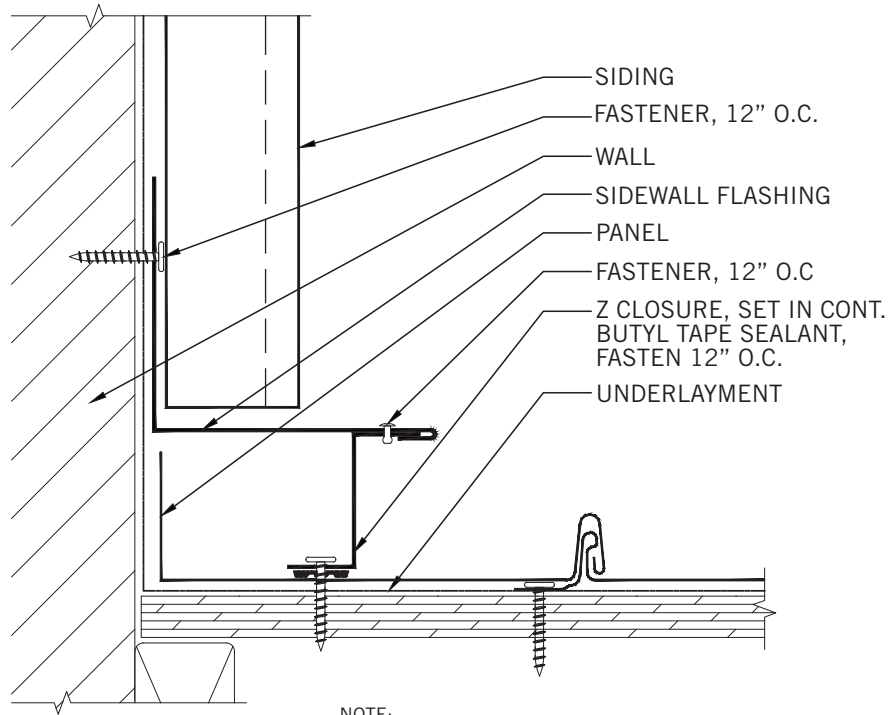

NOTE:
MINIMUM LAP ON ALL FLASHING IS 4". APPROVED SEALANT IN LAPS OF ALL FLASHING. TURN APPROVED UNDERLAYMENT 3" VERTICALLY MIN.

LOCKING ENDWALL

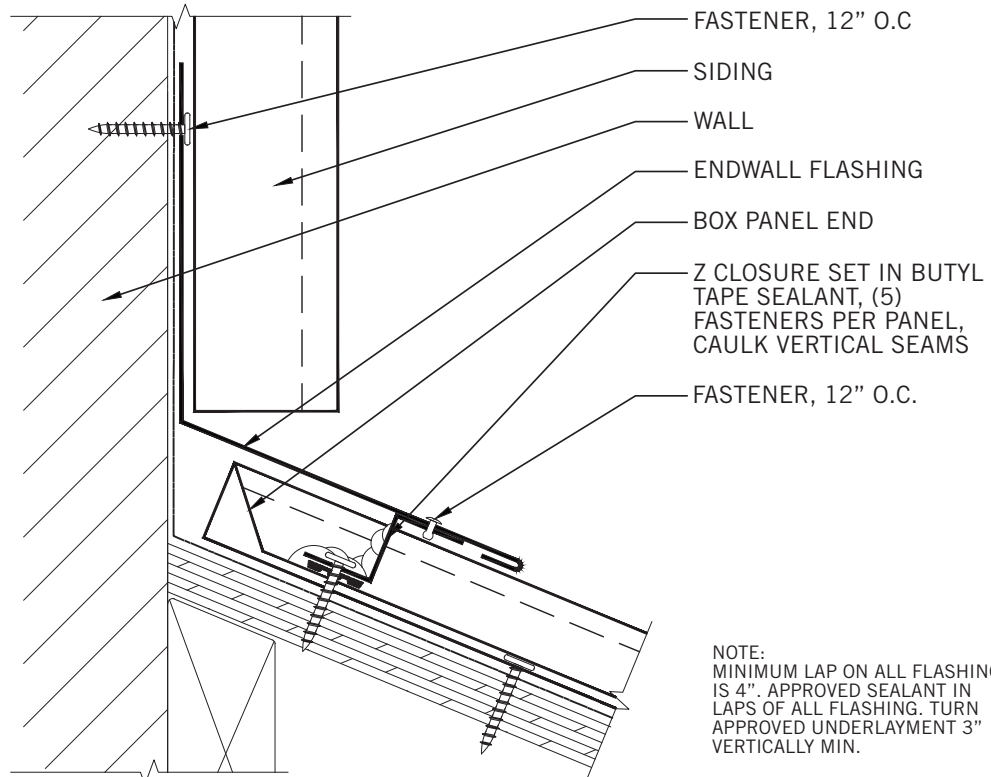

NOTE:
MINIMUM LAP ON ALL FLASHING IS 4". APPROVED SEALANT IN LAPS OF ALL FLASHING. TURN APPROVED UNDERLAYMENT 3" VERTICALLY MIN.

**Details are subject to change without notice.*

EPIC STEEL NAIL STRIP

W - VALLEY

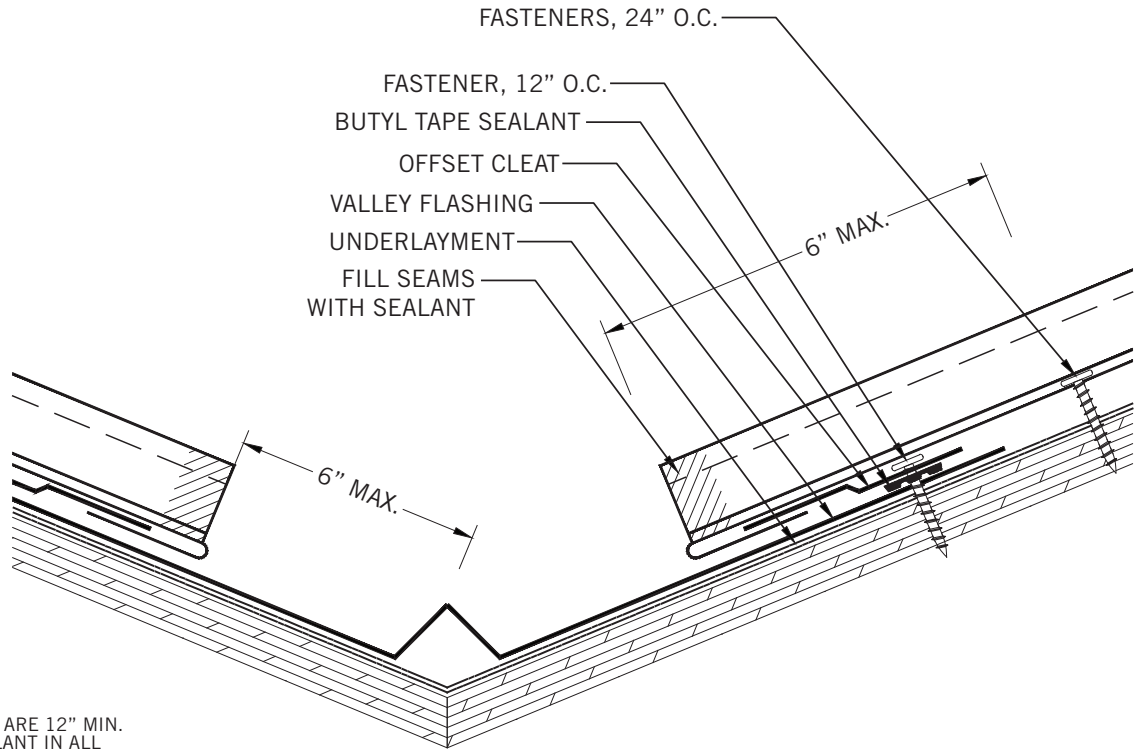

NOTE:
LAPS IN VALLEY ARE 12" MIN.
APPROVED SEALANT IN ALL
LAPS IN VALLEY. TWO ROWS OF
SEALANT BETWEEN VALLEY LAPS,
4" UP FROM LAP.

LOCKING GABLE

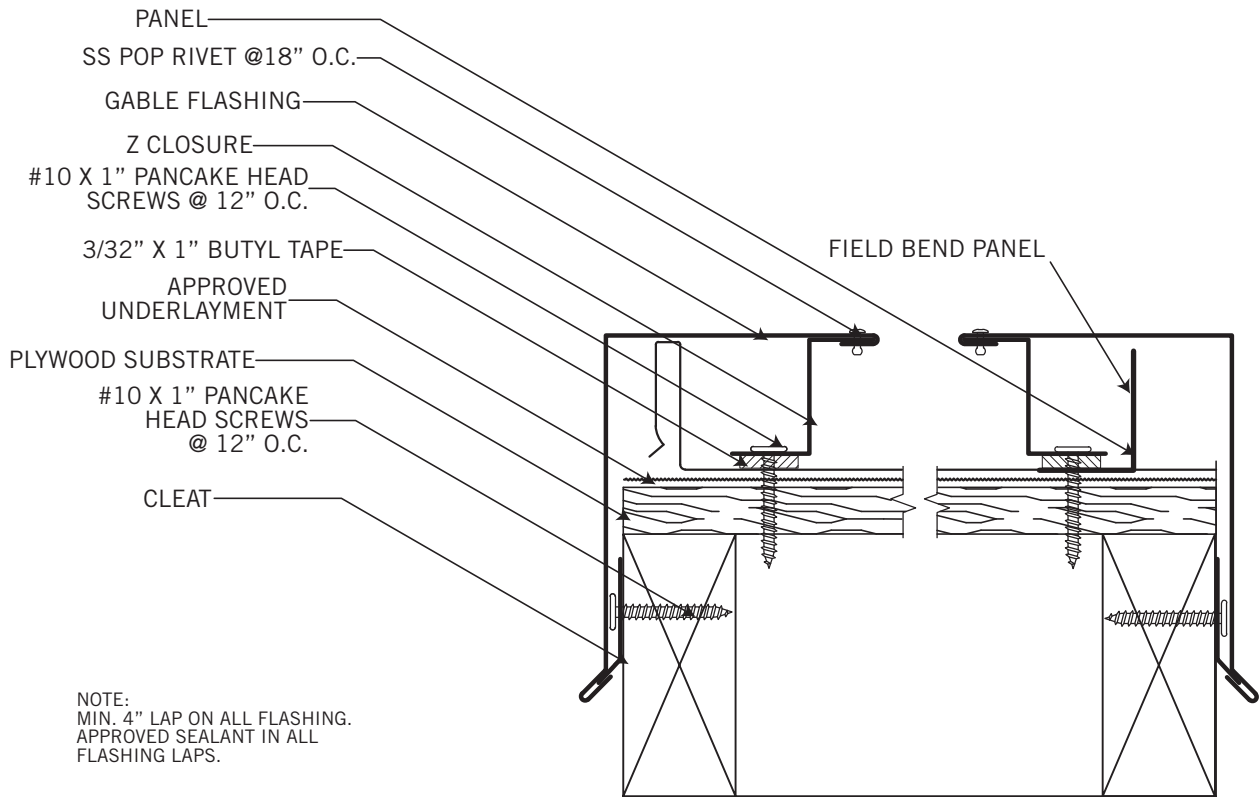

**Details are subject to change without notice.*

EPIC STEEL NAIL STRIP

PROW GABLE

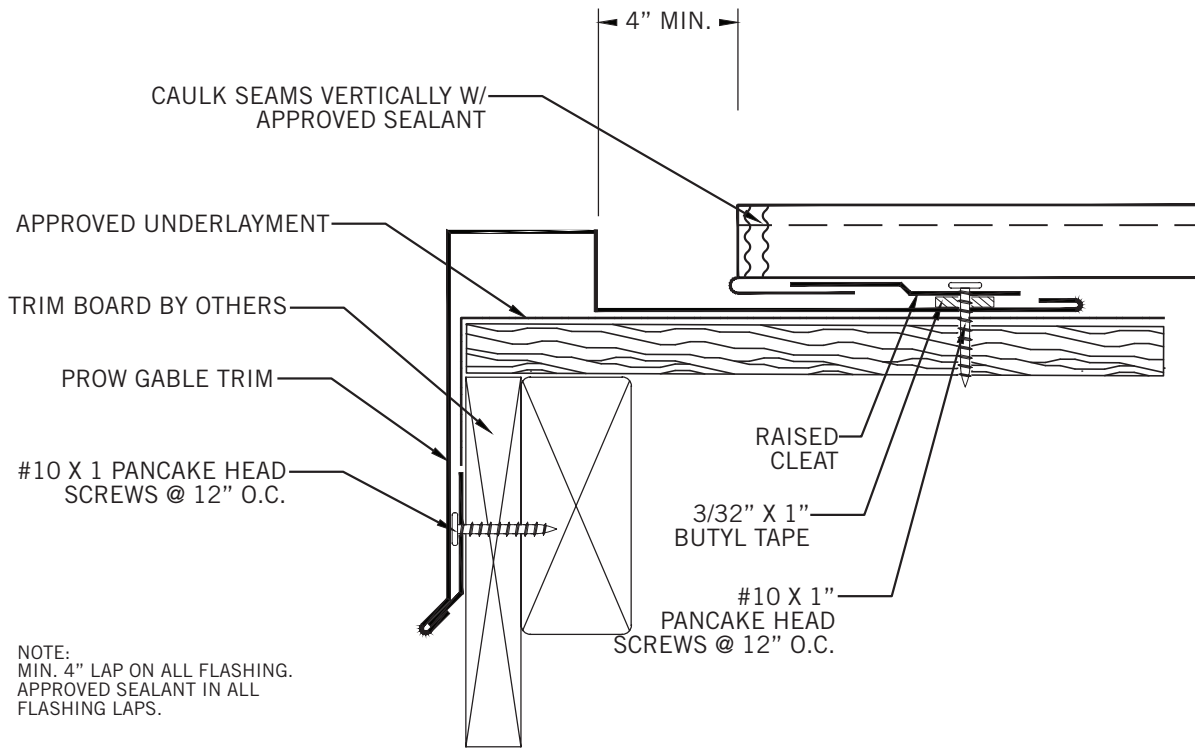

STYLE D AS GABLE

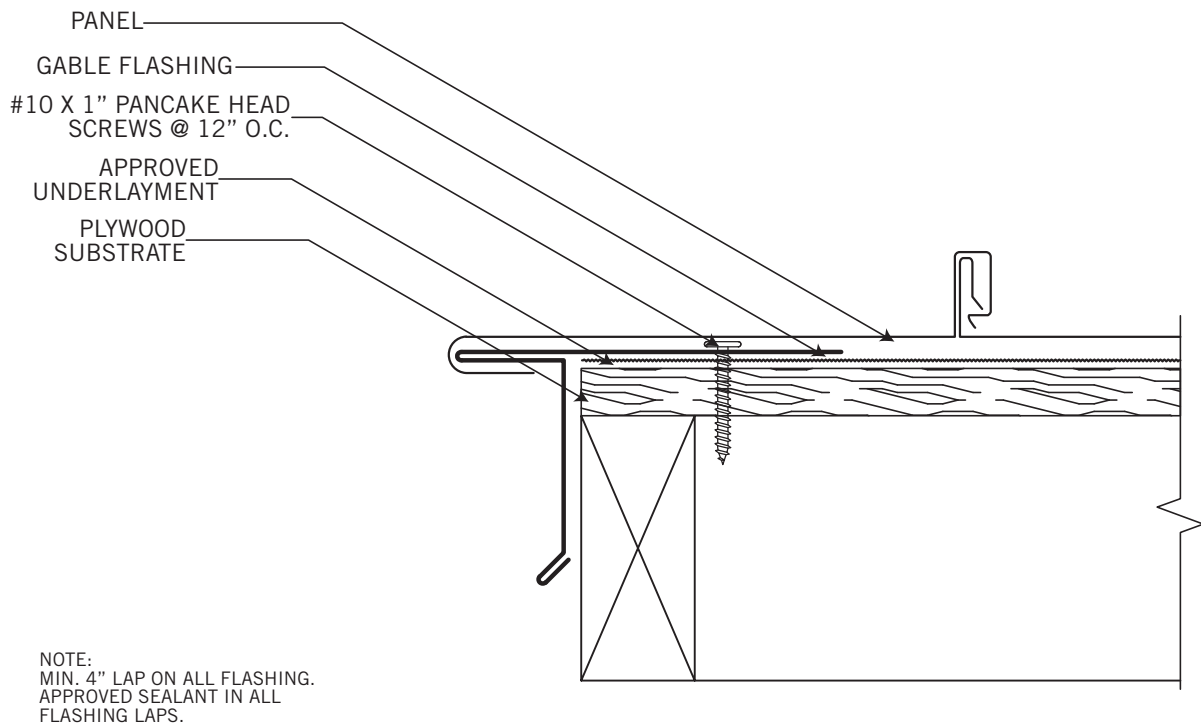

**Details are subject to change without notice.*

EPIC STEEL NAIL STRIP

HIGH EAVE

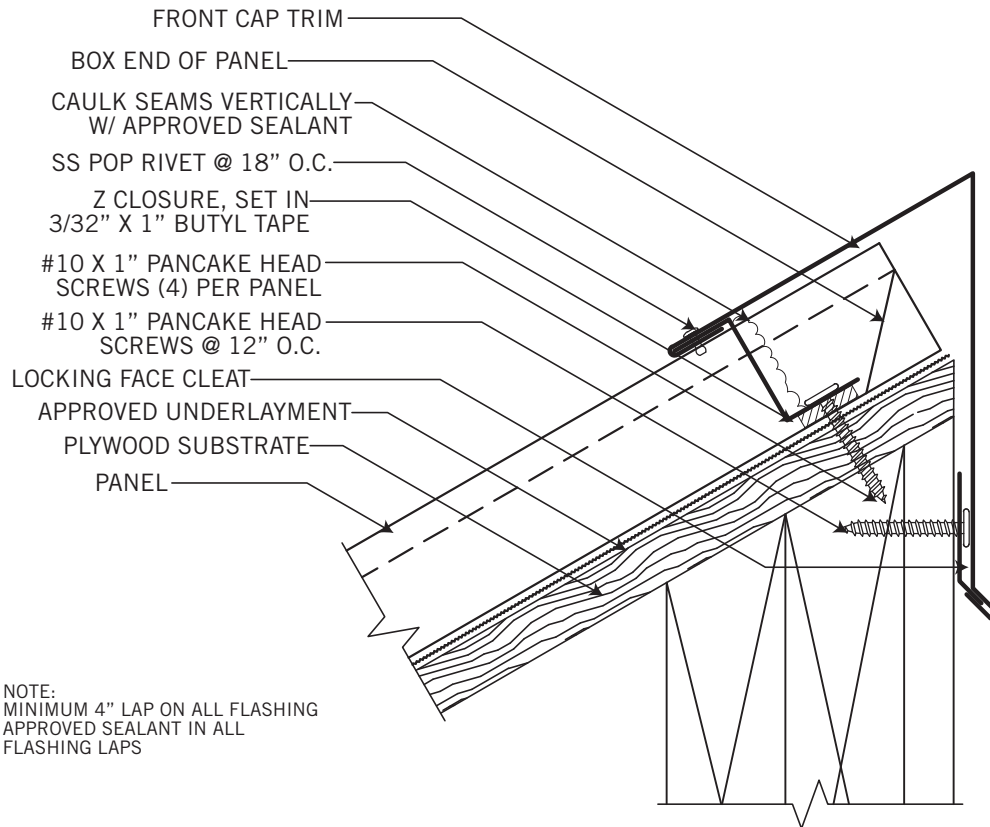

STYLE D AS HIGH EAVE

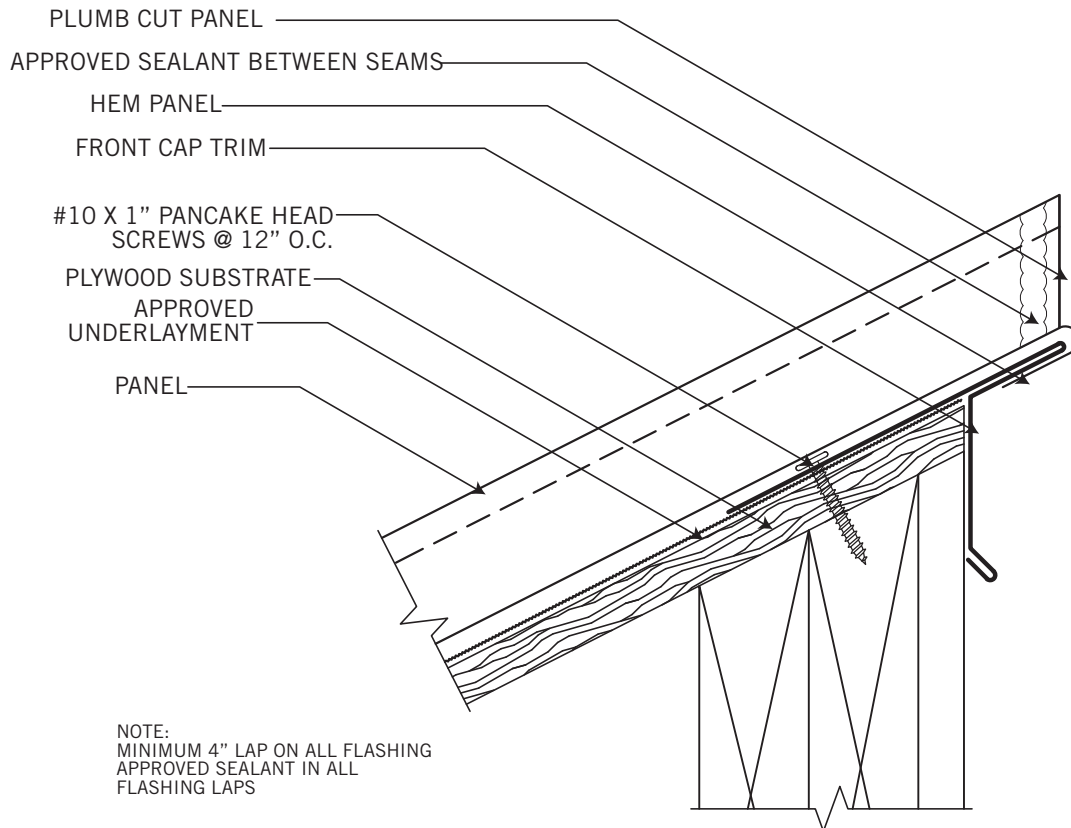

**Details are subject to change without notice.*

EPIC STEEL NAIL STRIP

STANDING SEAM UPPER TRANSITION

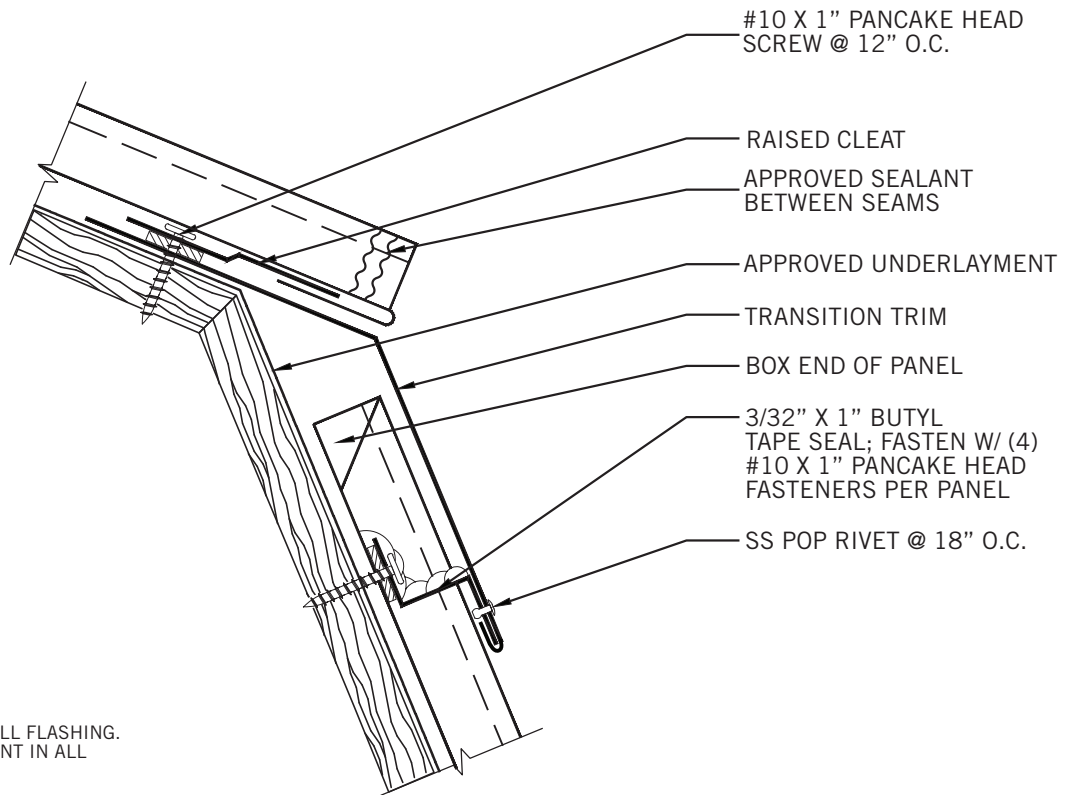

NOTE:
MIN. 4" LAP ON ALL FLASHING.
APPROVED SEALANT IN ALL
FLASHING LAPS.

STANDING SEAM LOWER TRANSITION

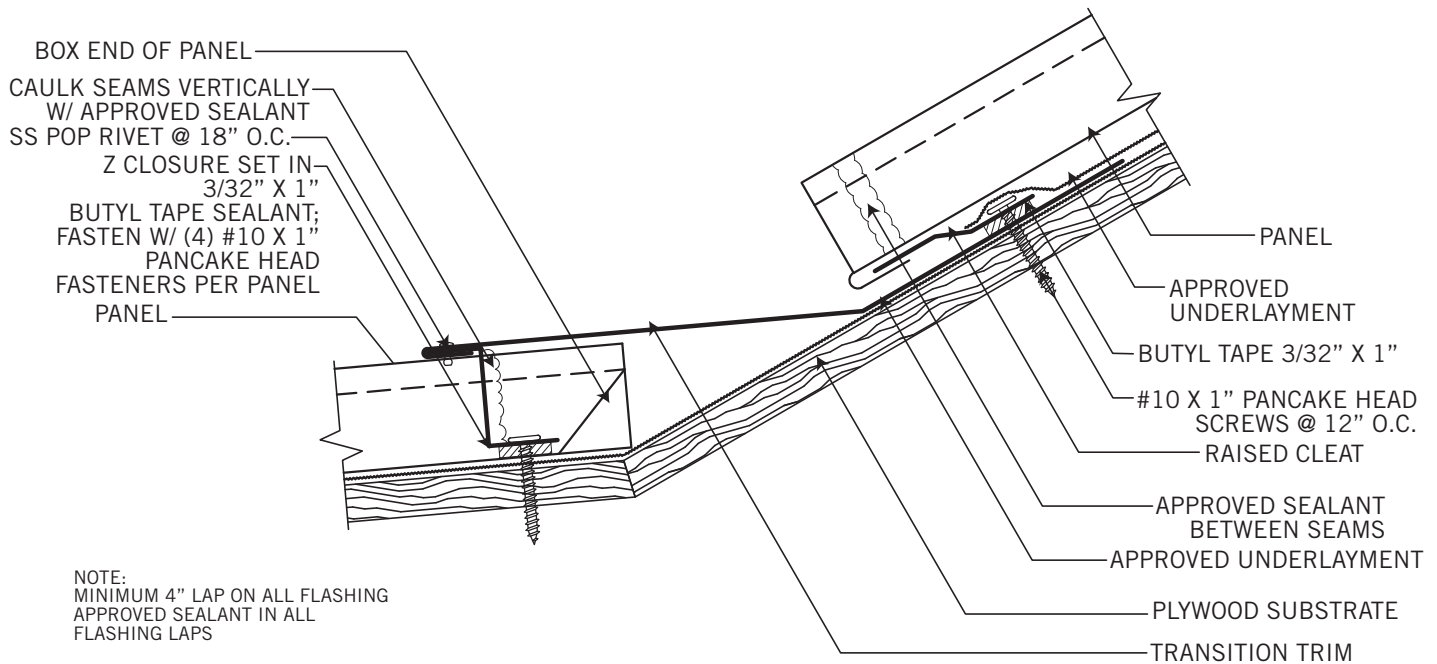

NOTE:
MINIMUM 4" LAP ON ALL FLASHING
APPROVED SEALANT IN ALL
FLASHING LAPS

**Details are subject to change without notice.*

EPIC STEEL NAIL STRIP

LOCKING INSIDE CORNER

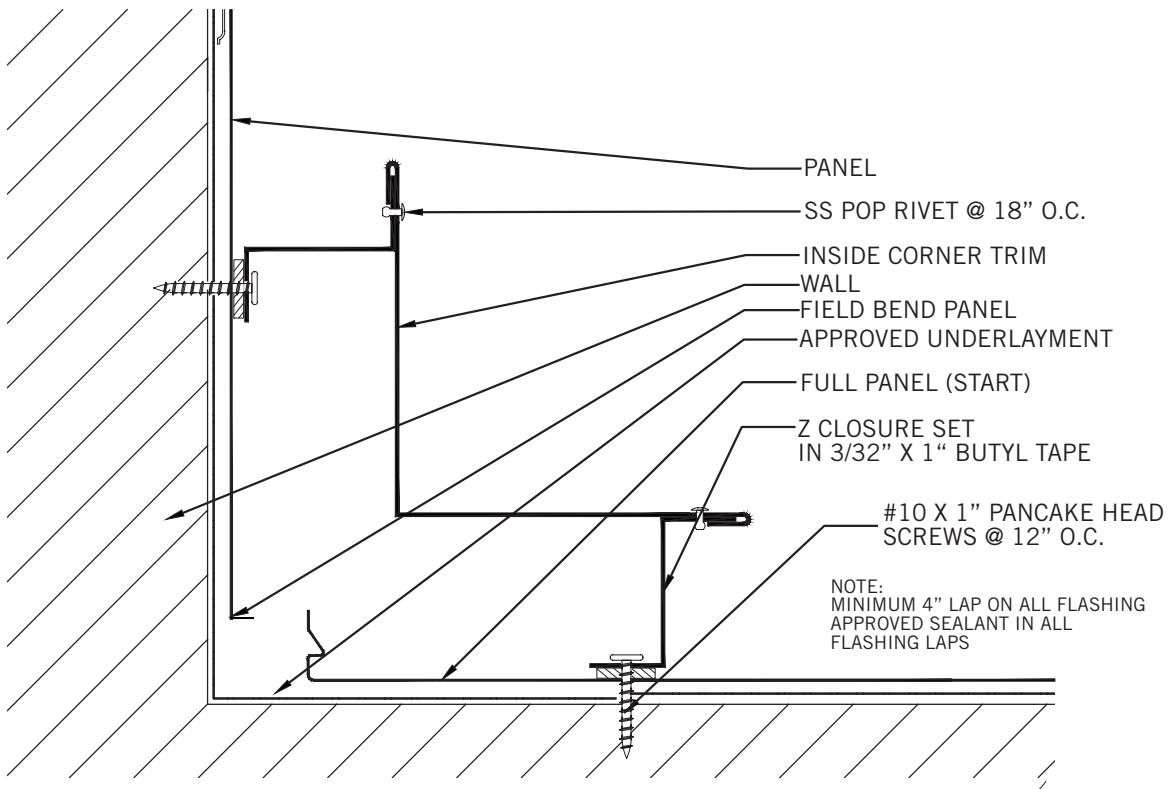

LOCKING OUTSIDE CORNER

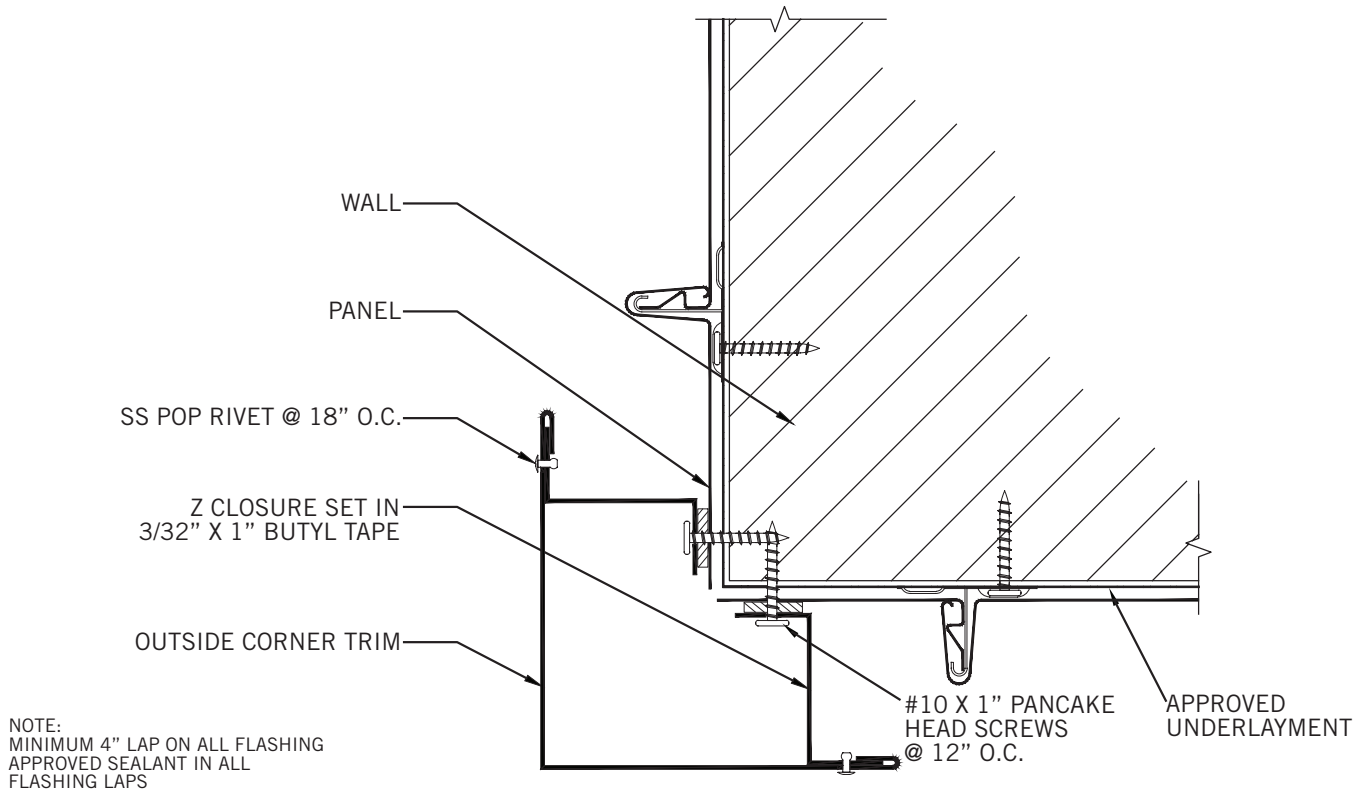

**Details are subject to change without notice.*

EPIC STEEL NAIL STRIP

STANDING SEAM WINDOW DRIP

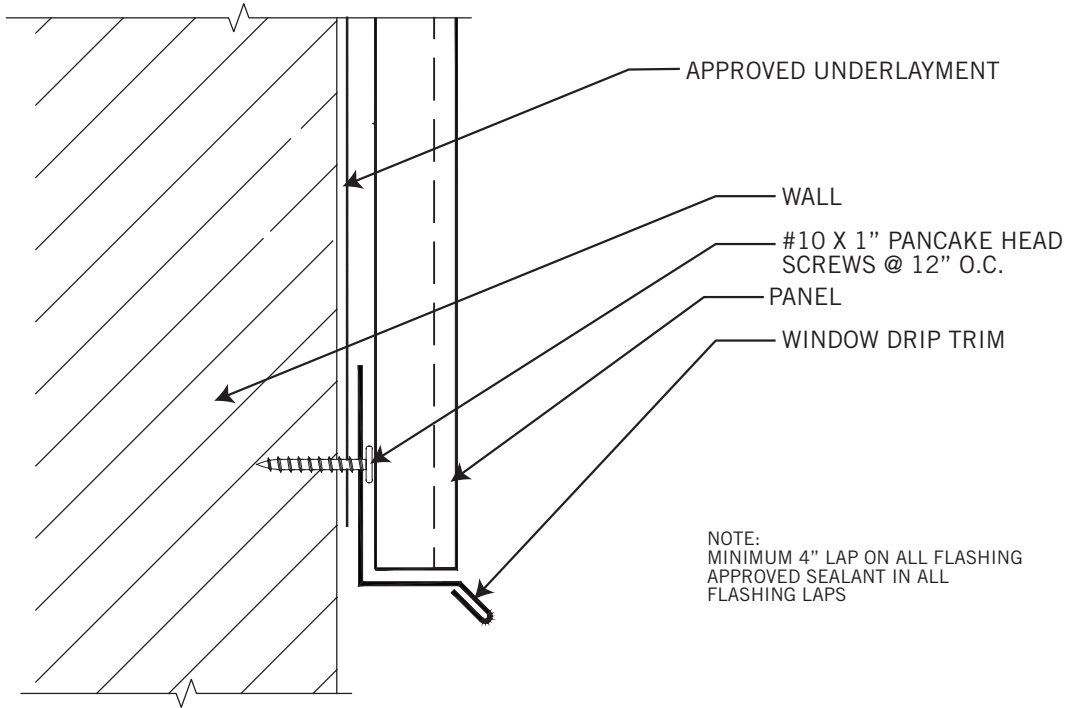

STANDING SEAM BASE TRIM

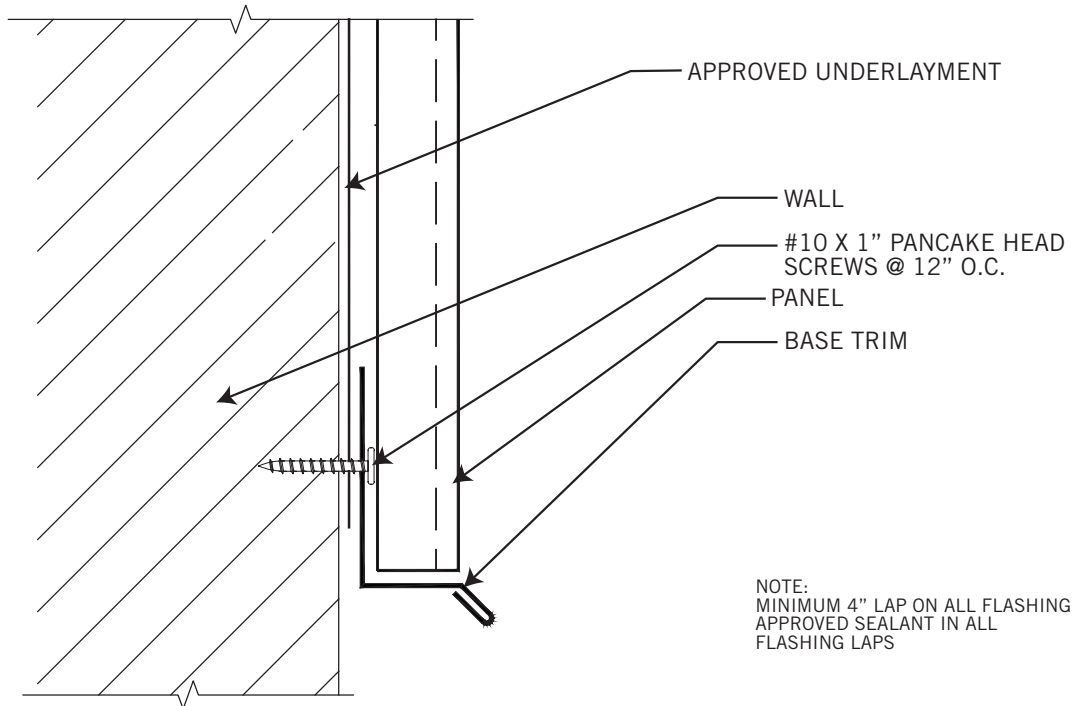

**Details are subject to change without notice.*

EPIC STEEL NAIL STRIP

J - METAL TRIM

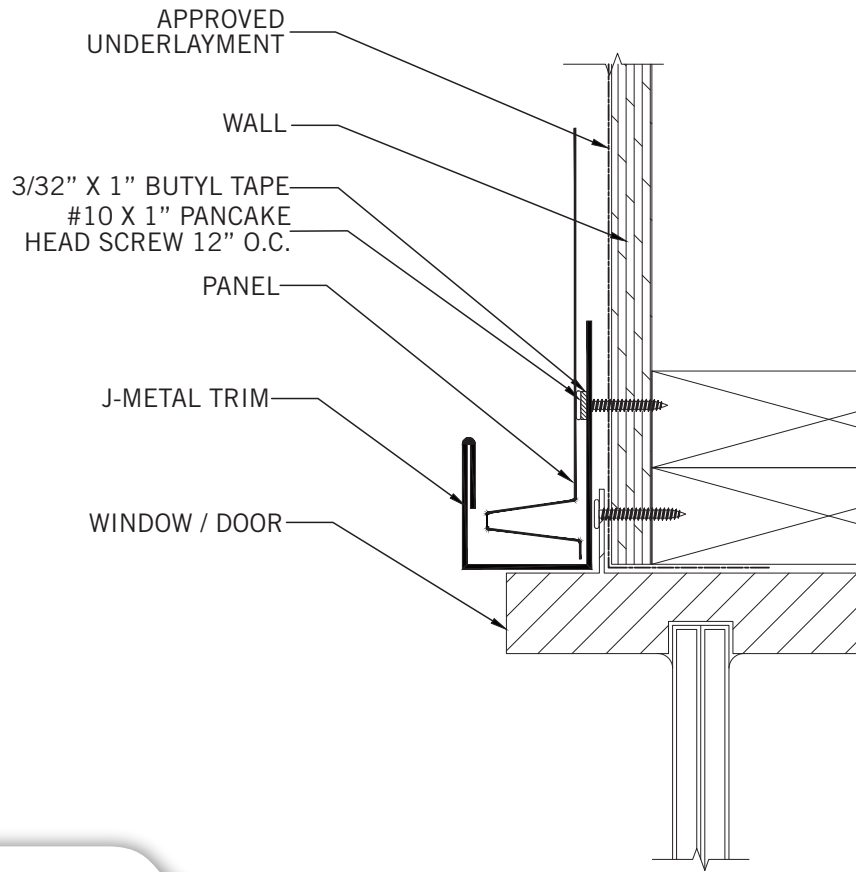

HEADER / SILL TRIM

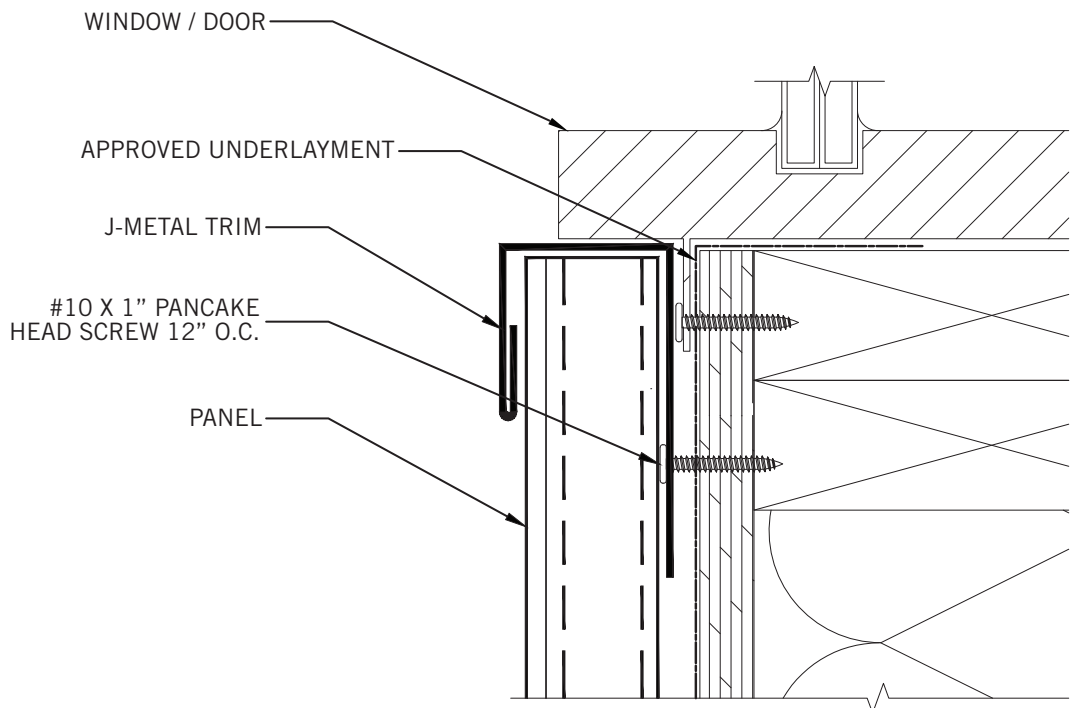

**Details are subject to change without notice.*

EPIC STEEL NAIL STRIP

PENETRATION DETAIL

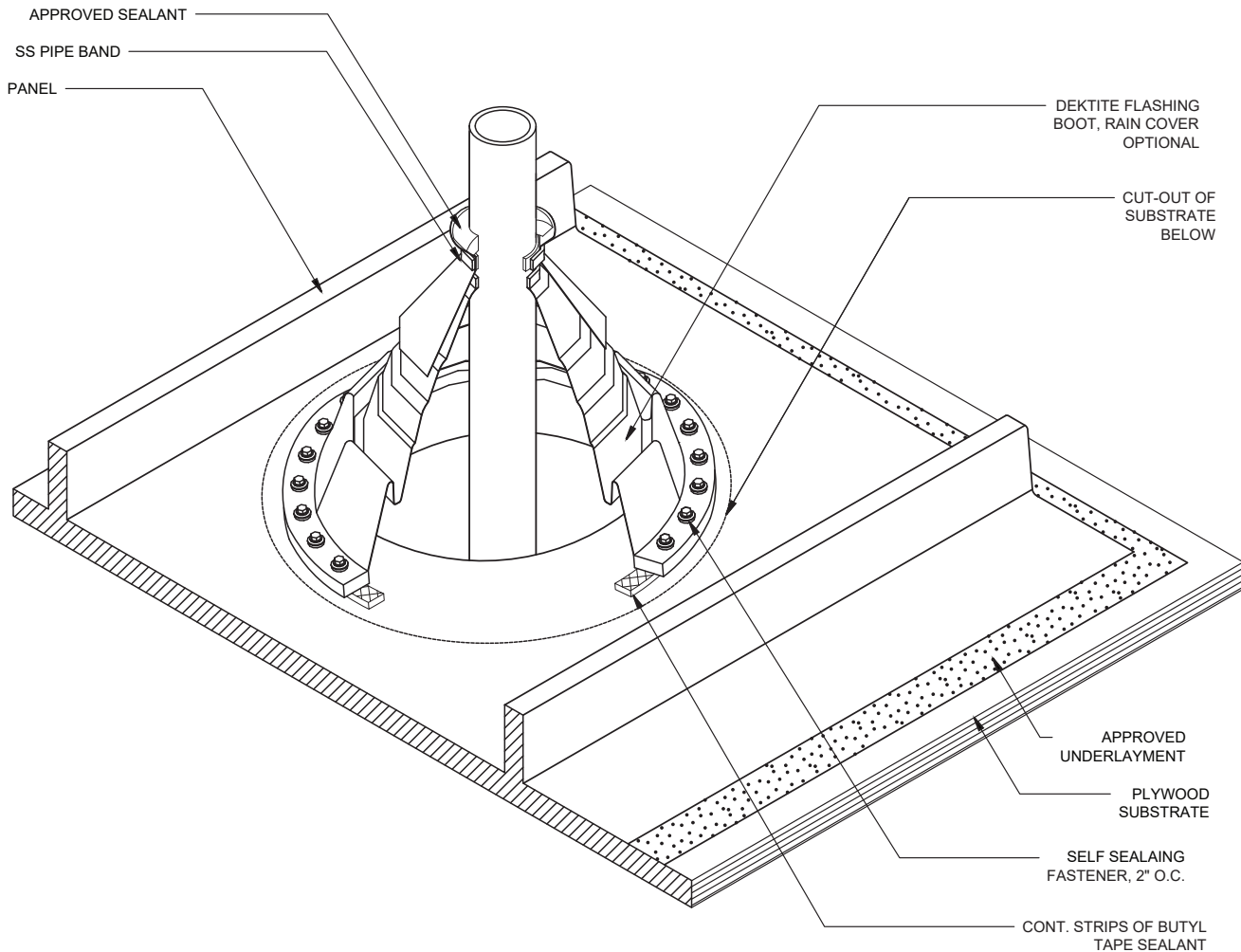

**Details are subject to change without notice.*