

# EPIC STEEL

# 3' DELTA RIB



3' DELTA RIB



# 3' DELTA RIB TRIM

## MATERIAL SPECIFICATIONS

**Gauge:** 28, 26

**Weight:** 1.98 lb. /LF, 2.67lb

**Steel Yield Stress:** 80,000 psi  
Galvalume Steel Gauge, AZ-50

**Paint System:** Stormshield Xt-40,  
Energy Star® Rated, Silicone  
Modified Polyester

**Warranty:** 40 Years

**Available Material Type:**  
Painted, Galvalume®

**Gauging System:** Epic Steel follows the national A.I.S.I. (American Iron and Steel Institute) specifications manual for tolerances in galvanized sheet metal.

All gauges conform to ASTM A792 and ASTM A653 Grade E (80,000 min. yield)/ or Grade D (50,000 min. yield) unless otherwise designated at time of order.

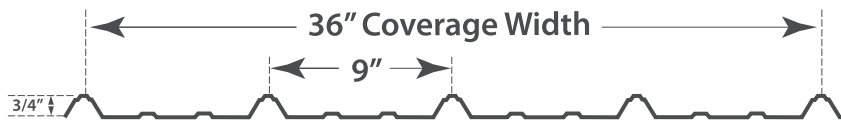

Made in Montana - Refer to Color Chart for Color Availability

## LOAD TABLES

Span (ft.)	Three or More Span Condition		
	28 Gauge & 80 ksi		
	LL(S)	LL(D)	OUTWARD(S)
3	41.2	36.7	39.2
4	23.2	15.5	22.1
5	14.8	7.9	14.1

- 1 1/2" Bearing Length
- Load Span Tables Based on Working Stress
- Flexural Design analysis according to AISI "Specification for the Design of Light Gauge Cold-Formed Steel Structural Members" May 1981
- Continuous Span Loading applies to sheets continuous over three or more spans
- Weight of sheet has not been allowed for when calculating live load and Uplift.
- Deflection (L/180) limiting live load based on deflection of span.
- Metal thickness based on minimum ASTM specifications for allowable load calculations
- Loads may be increased by 1/3 for wind loads

Areas of discontinuity are subject to higher spikes in wind pressure, therefore a different coefficient in wind pressure will need to be considered and multiplied by a factor of 1.5

Data from: 1994 UBC Table 16-F

*Note: The load tables have been compiled for the design of steel roofing and siding used in conjunction with either wood or steel framed structures. EPIC Steel assumes no responsibility, either expressed or implied, for its use.*

## APPLICATION DETAILS

**Minimum Slope Requirement:** 3:12

**Screw Application:** #10 Wood grip fasteners are designed for use with dimensional lumber, #14 Wood grip fasteners are designed for use with plywood sheathing, OSB, and wafer wood (7/16" minimum thickness). #12 Tek screws are designed to be used with structural steel up to 3/16" in thickness.

**Roof Application:** Fasteners to be applied along side every rib and attached to each purlin, 2' on center. Please note that it is the responsibility of the builder to ensure that purlins are adequately spaced to meet specific engineering requirements.

EPIC Steel is neither partially nor solely responsible for improper installation or defects as a result of installation.

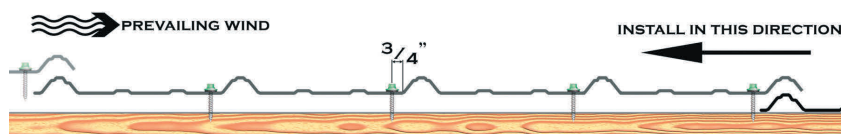

## SCREW FASTENING - EAVES & END LAPS



# 3' DELTA RIB STANDARD TRIM

28 GA.  
(10'1" / Stick)

3' DELTA RIB STANDARD TRIM

**Standard Ridge Cap**

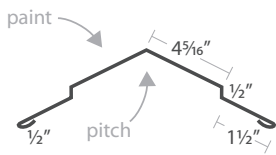

**Gable**

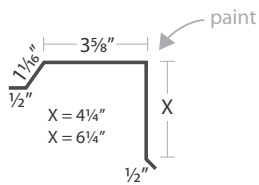

**Mini Gable**

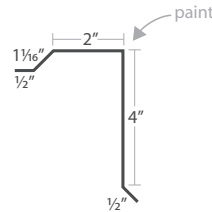

**Eave**

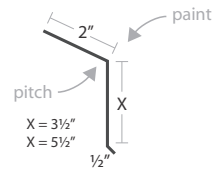

**Style-D Eave**

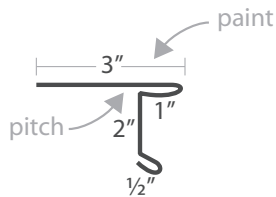

**High Eave**

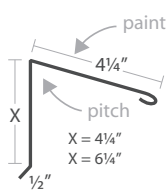

**W-Valley**

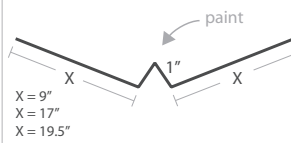

**Endwall**

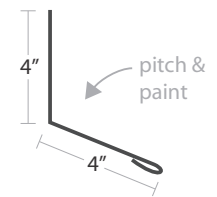

**Sidewall**

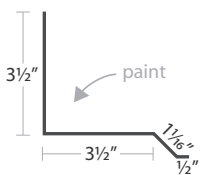

**Lower Transition**

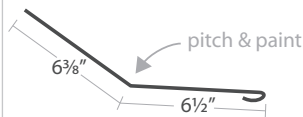

**Upper Transition**

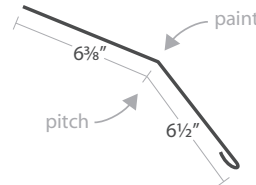

**Snow Stop**

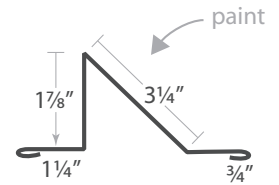

**3/4" J-Metal**

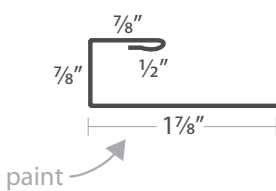

**F+J 3/4" x 3/4"**

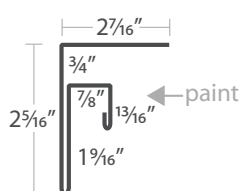

**F+J 1/2" x 3/4"**

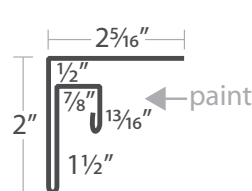

**Outside Corner**

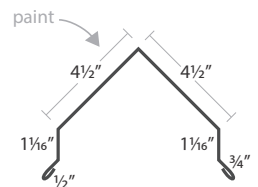

# 3' DELTA RIB STANDARD TRIM

28 GA.  
(10'1" / Stick)

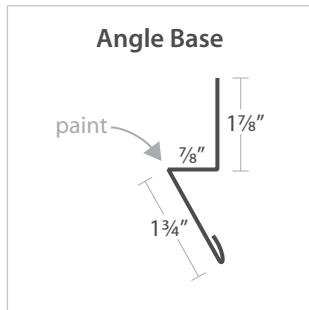
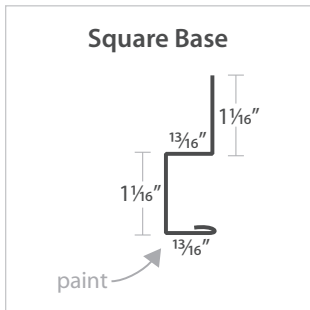
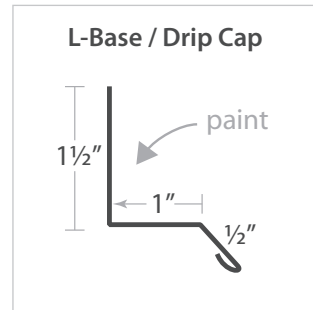
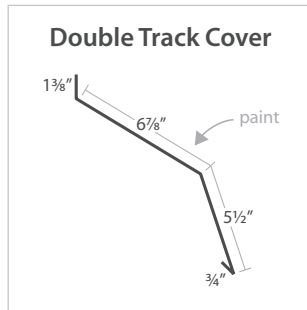
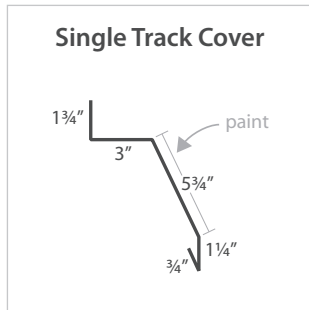
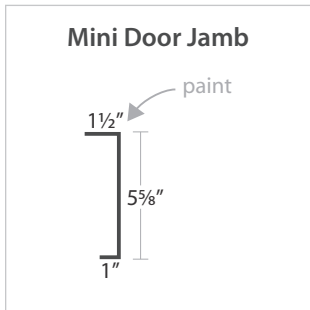
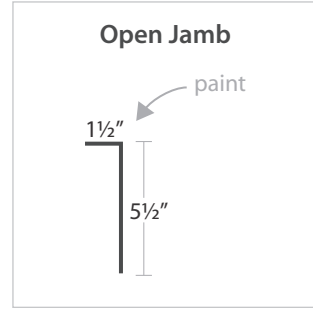
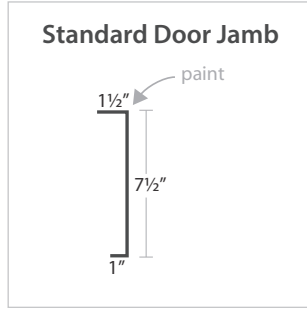
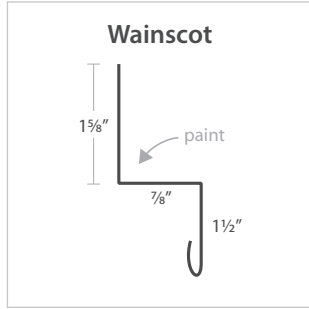
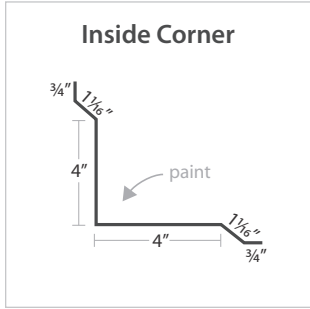

3' DELTA RIB STANDARD TRIM